

Hot-rolled structural steel shapes.

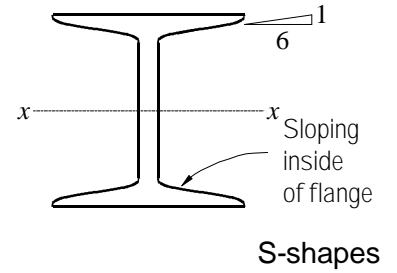

I-shaped cross-sections

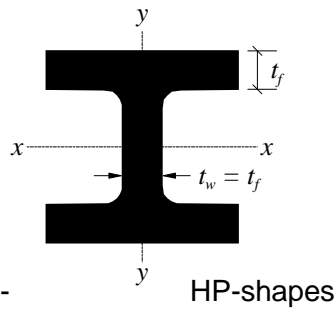
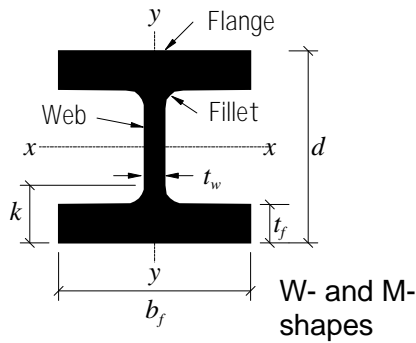
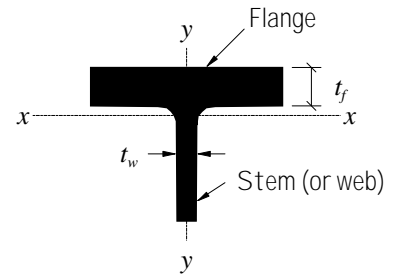
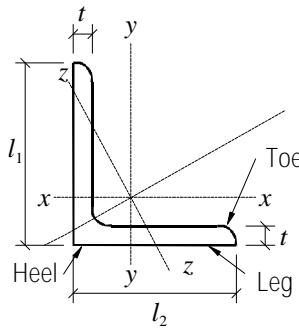
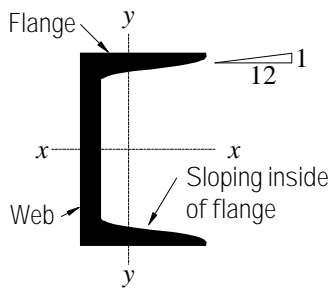

Tubular products

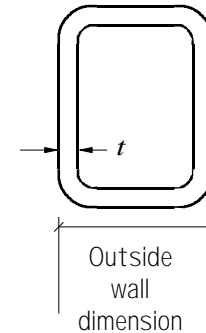
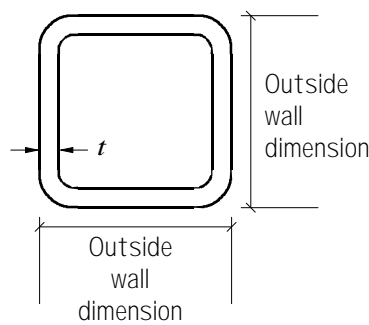
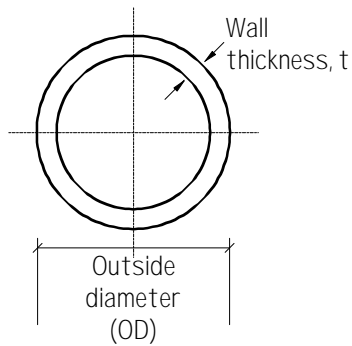
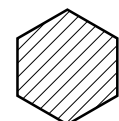
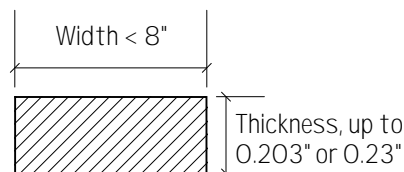
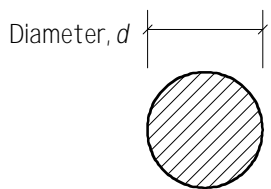
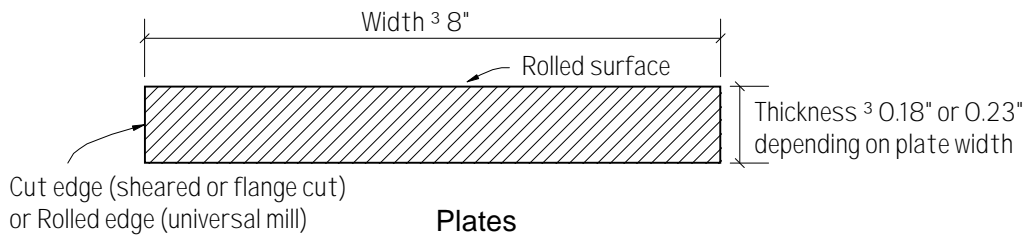
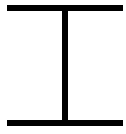

Plate and bar products



Common structural shapes



Wide flange (W-section)



American standard beam (S-section)

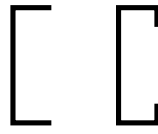

Channels

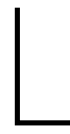

Angle

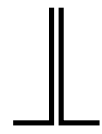

Double angle

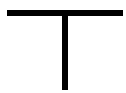

Structural tee



Pipe section



Structural tubing

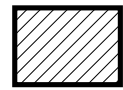

Bars



Plate

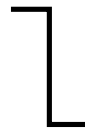

Zee

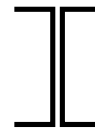

I-shaped double channel

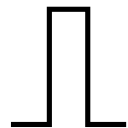

Hat section

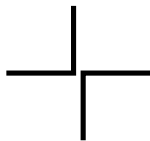

Starred angle



Cable

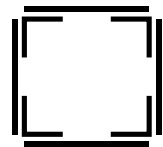
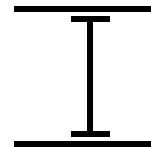
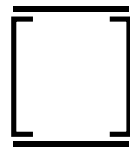

Built-up sections